

# CanSat 2017

# YARIŞMA TEMASI

**#4850**  
**SATAREL**

# TAKIM ÜYELERİ KİMLER?

**#4850**  
**SATAREL**

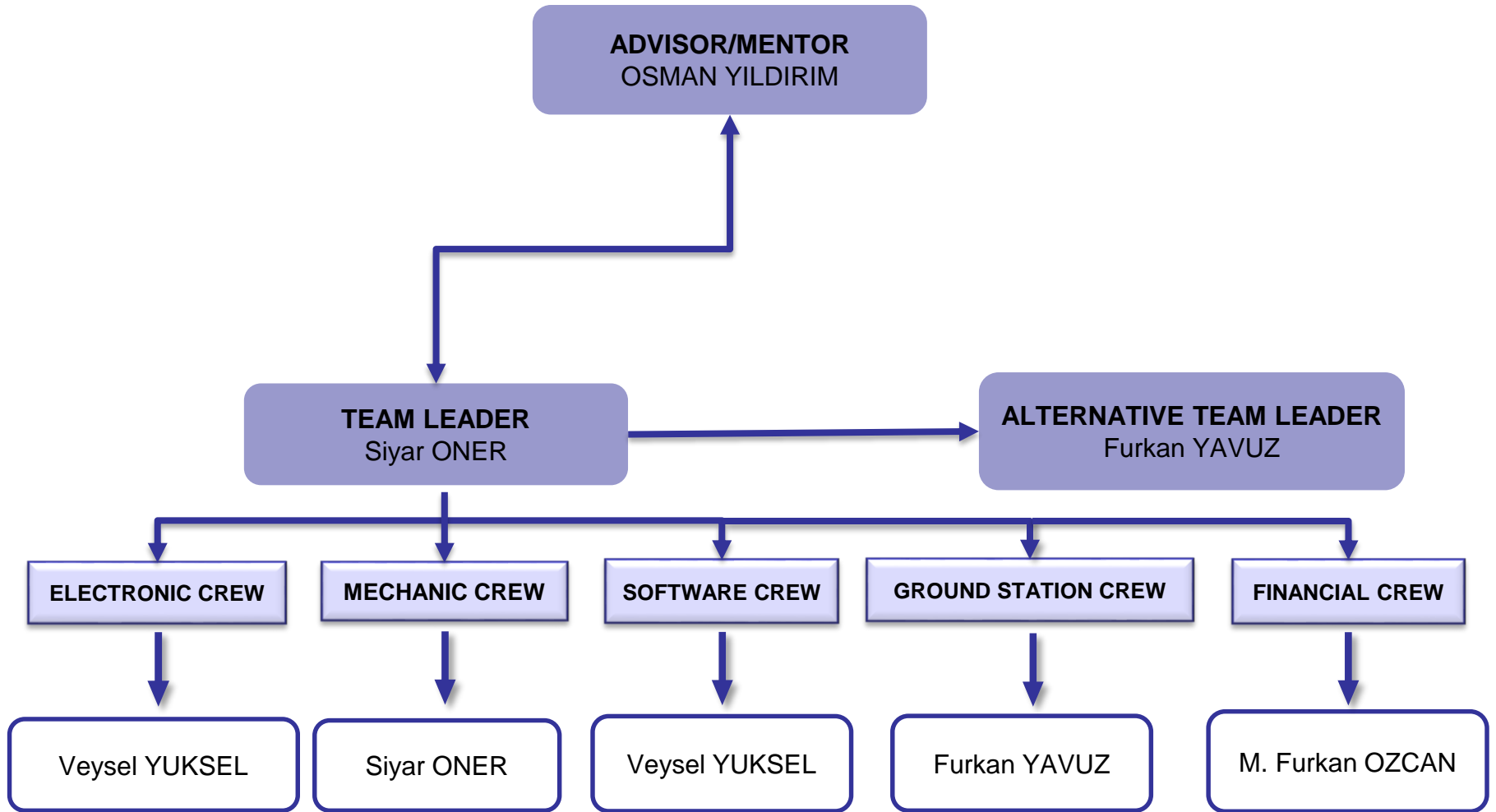

# SENARYO NEYDİ?

**#4850**  
**SATAREL**

## Decent Control Mechanism:

1. Parachute opens when container is separated from the rocket.
2. Container will descent to 400 meters by parachute with 17.07 m/s velocity.
3. Container cover will open at 400 meters and glider will be released.
4. Glider will glide in a circular pattern by rudder angle with 7.67 m/s .
5. Container will decent by parachute with 12 m/s after the glider release
6. Container and glider will be landed

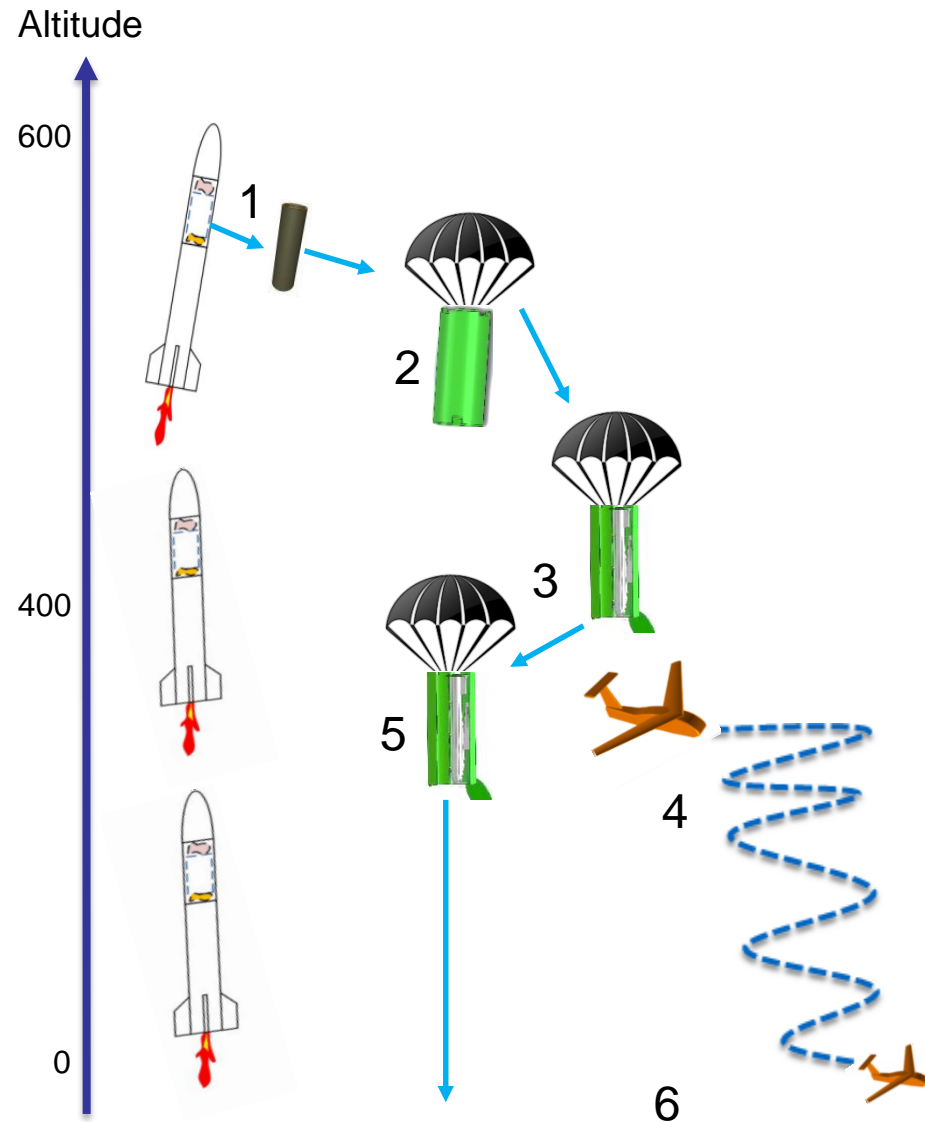





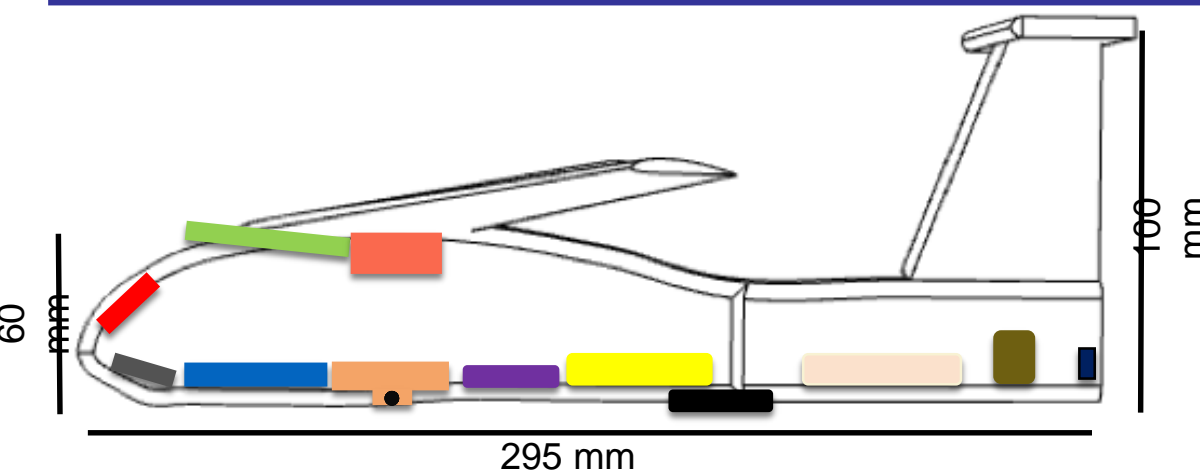







# SATAREL TAKIMI NELER YAPTI?

**#4850**  
**SATAREL**



## ➤ Dimension

**S**

-  Arduino Uno : 68.6 / 53.4 / 25
-  Camera : 24.99 / 24.04 / 7 mm
-  BMP 180 : 10.53 / 13.48 / 2.57 mm
-  XBee : 24.40 / 33.30 / 3 mm
-  RTC(DS3231) : 38 / 22 / 14 mm
-  XBee Antenna : 18.4 / 7.5 / 0.15 mm
-  MAG3110 : 13.3 / 14.5 / 3 mm
-  DS18B20 : 5 / 4 mm
-  Buzzer : 19.50 / 26.80 / 12 mm
-  Pitot tube : 86mm
-  MS4525DO : 12.5 x 10 mm
-  Memory : 15 / 11 / 1 mm

PV panel distribution :

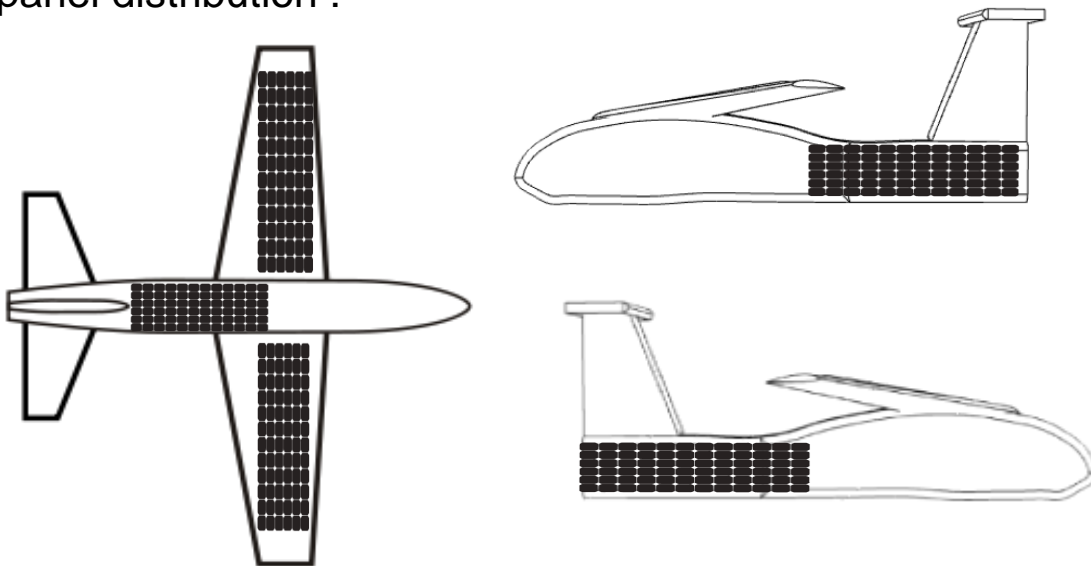

Team Logo  
Here  
(If You Want)

# Physical Layout



## Container

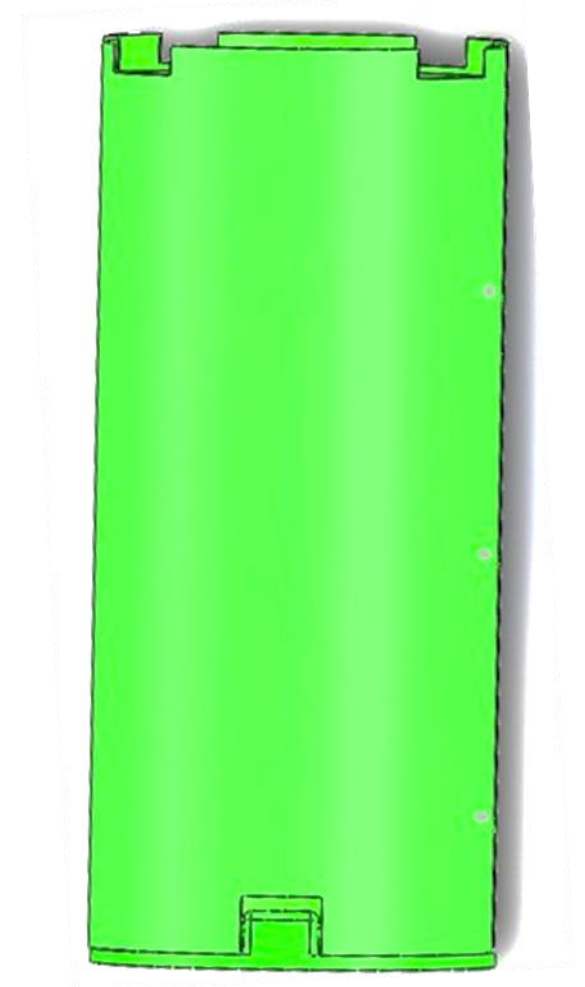
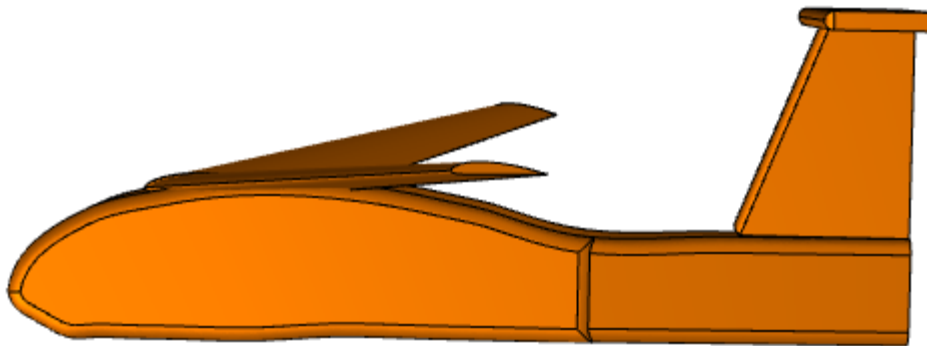
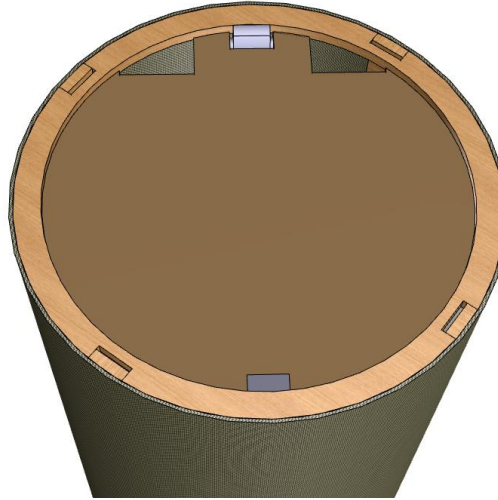
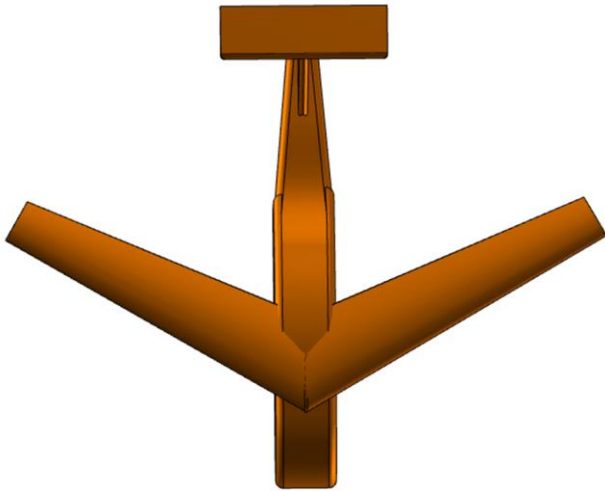



Team Logo  
Here  
(If You Want)

# Physical Layout

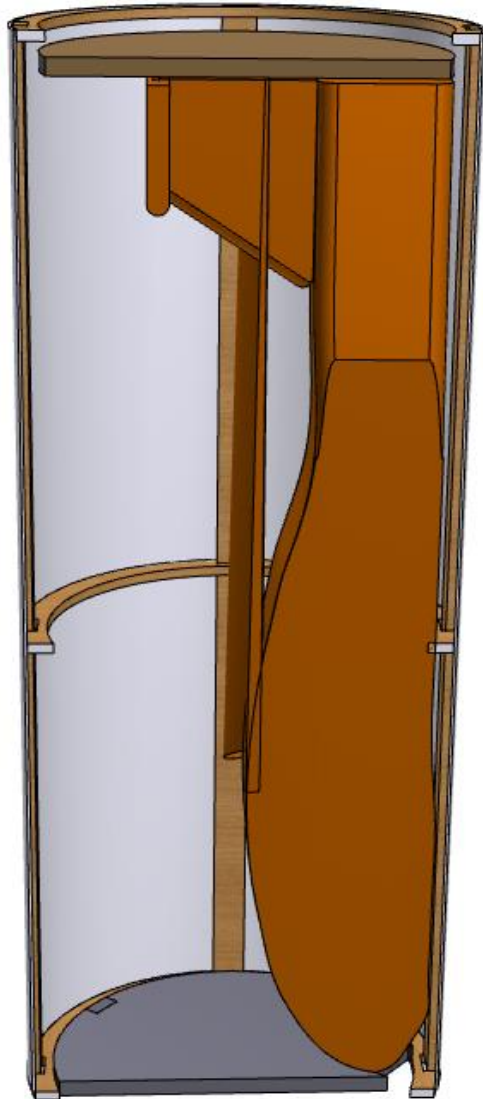

- Arduino Uno : 68.6 / 53.4 / 25 mm
- XBee Antenna : 18.4 / 7.5 / 0.15 mm
- BMP 180 : 10.53 / 13.48 / 2.57 mm
- Buzzer : 19.50 / 26.80 / 12 mm
- XBee : 24.40 / 33.30 / 3 mm
- RTC(DS3231) : 38 / 22 / 5 mm
- DS18B20: 5 / 4 mm
- Memory : 15 / 11 / 1 mm
- Battery : 15 / 11 / 1 mm

# SATAREL UYDU TAKIMI BİR DİZİ ÖLÇÜM YAPTI

**#4850**  
**SATAREL**

**VSWR**

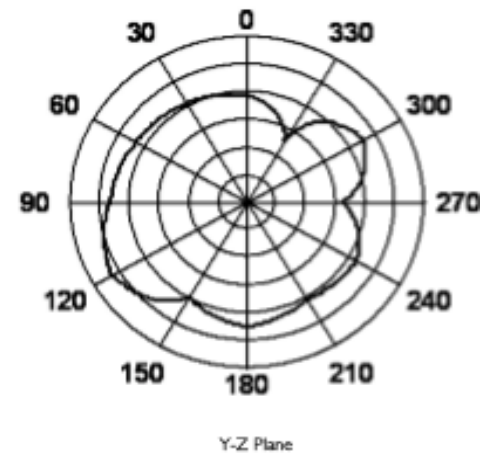
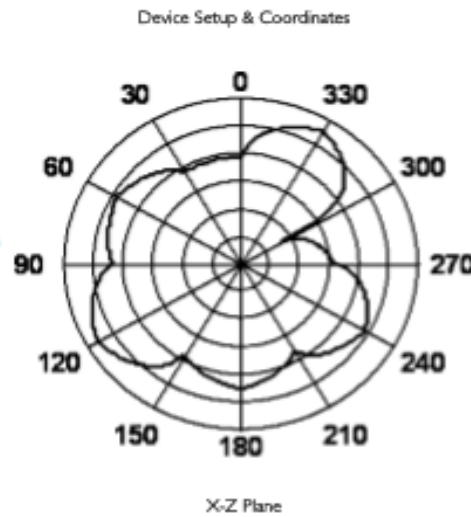
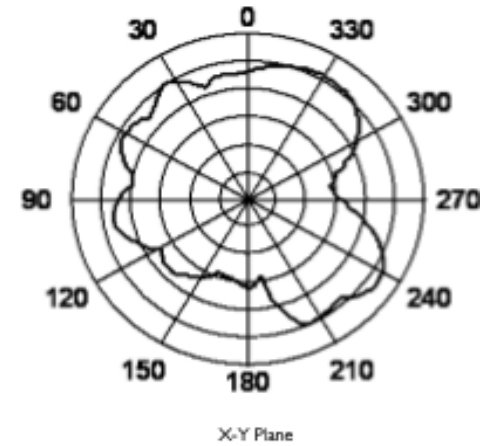
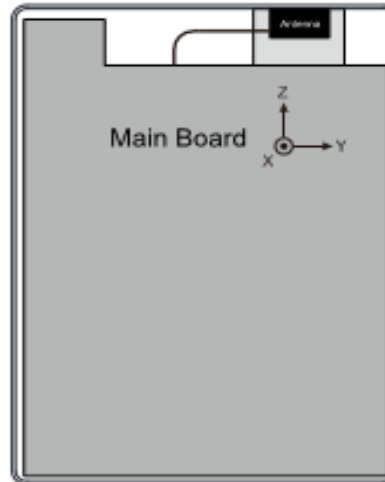
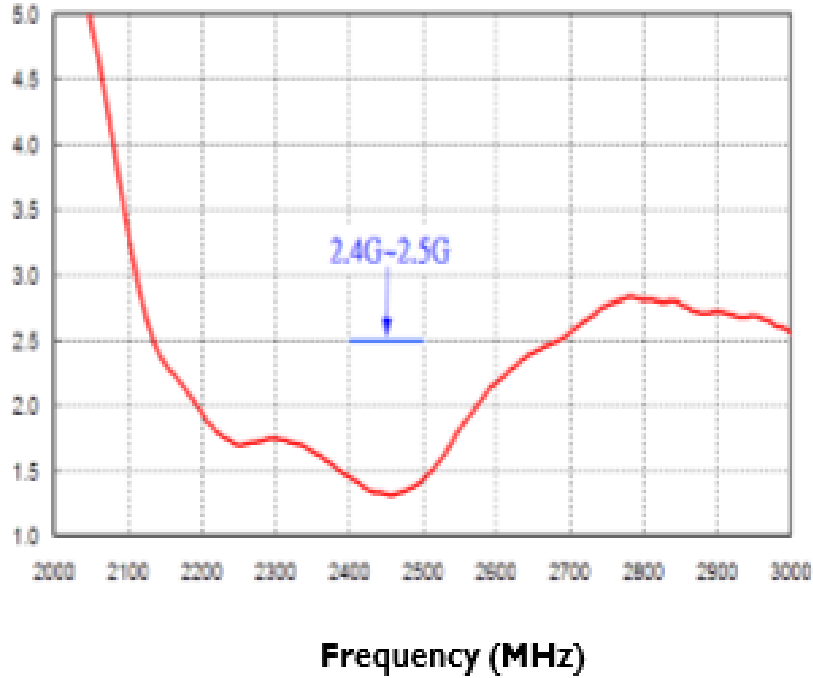

**VSWR**

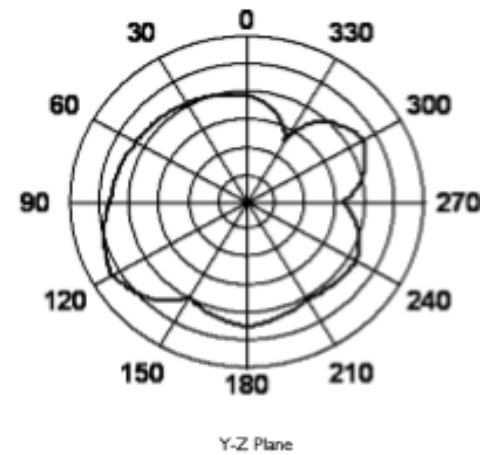
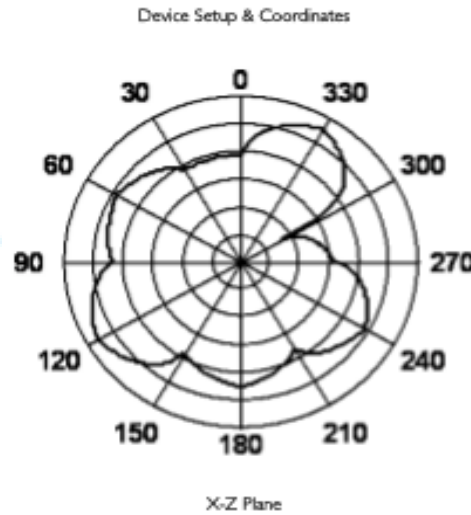
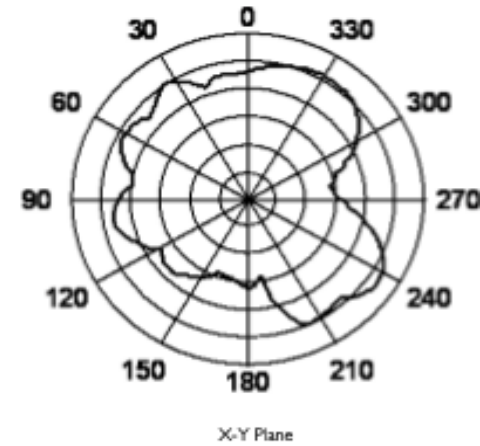
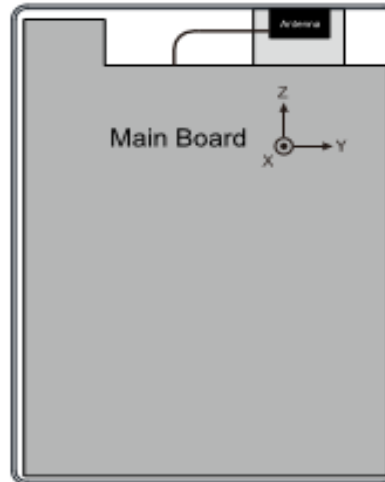
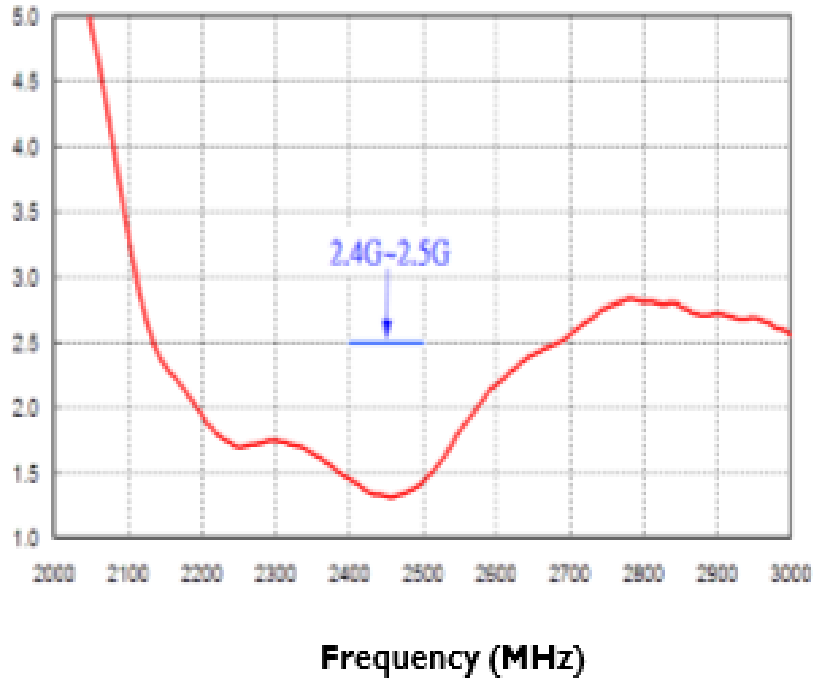

# SATAREL UYDU TAKIMI YARIŞMADA İLK 8 TAKIM İÇİNE GİRME BAŞARISI GÖSTERDİ

**#4850**

**SATAREL**